

# VCM.

service@vcm-gruppe.de

## VCM 6-Treppenregal "Nitas"

1055(W)x1047(H)x292(D)mm

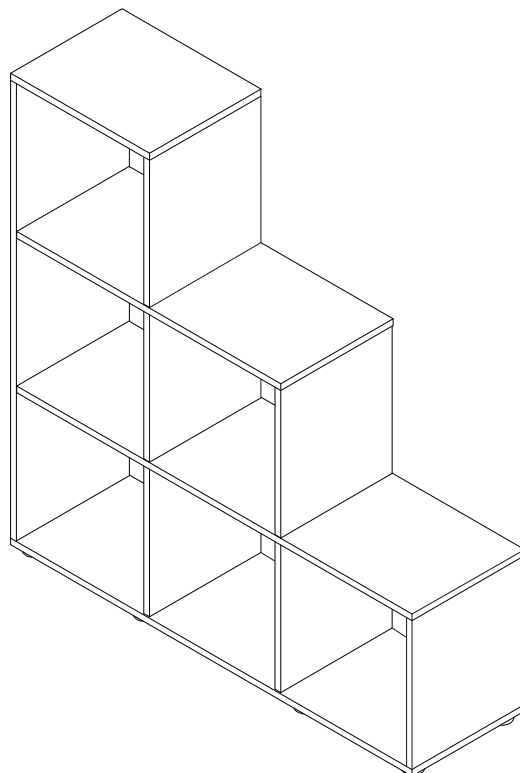

Achtung: Bei mangelhafter Montage besteht Gefahr für die Sicherheit.  
Möbel unbedingt an der Wand montieren!!!!

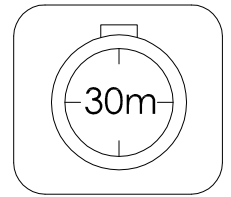
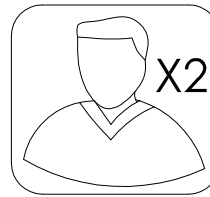
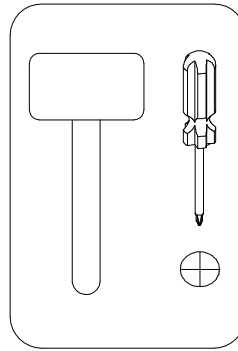
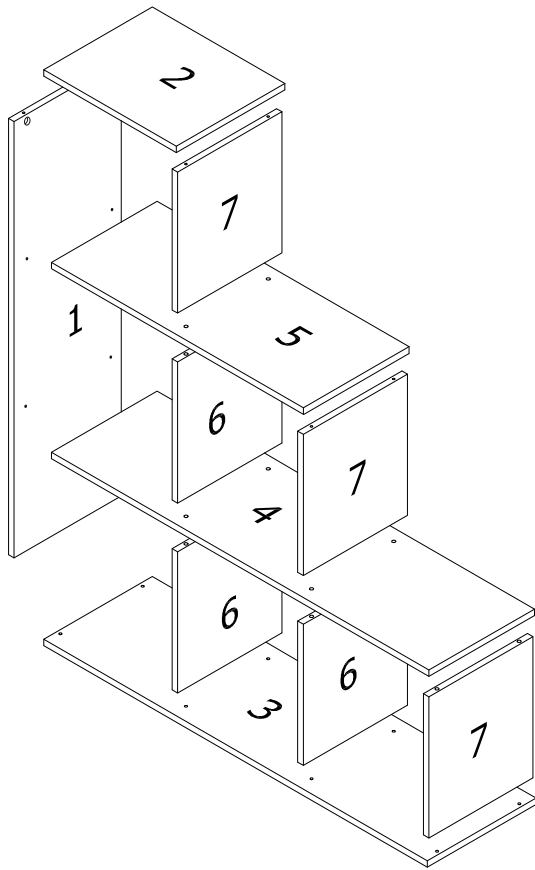

## BESCHLAGE

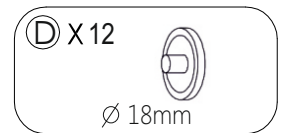
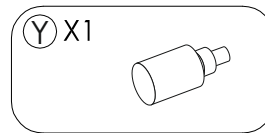
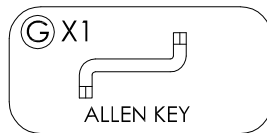
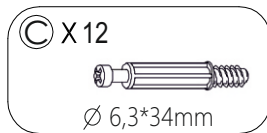
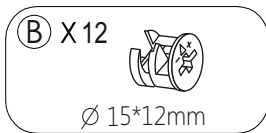
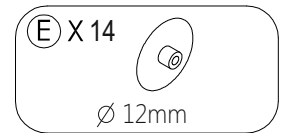
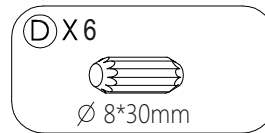
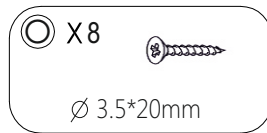
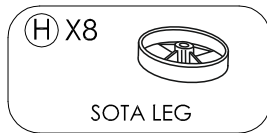
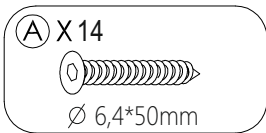

1

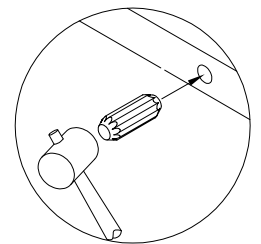
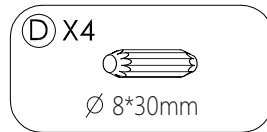
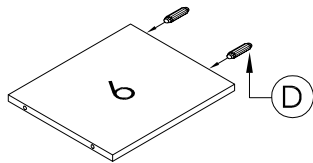

2

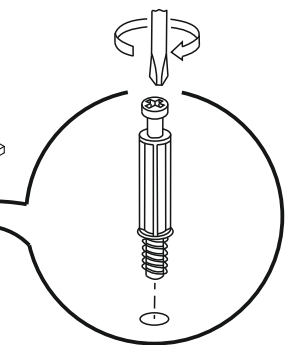
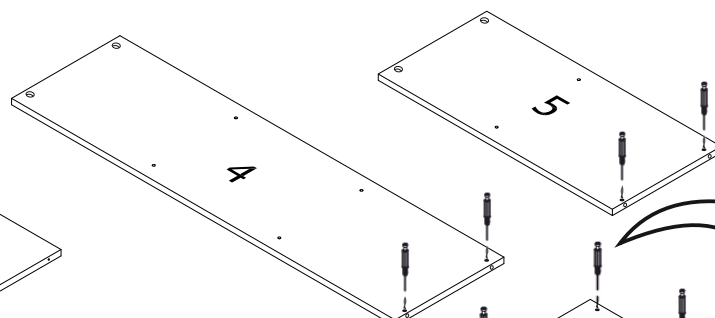
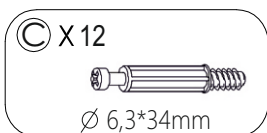
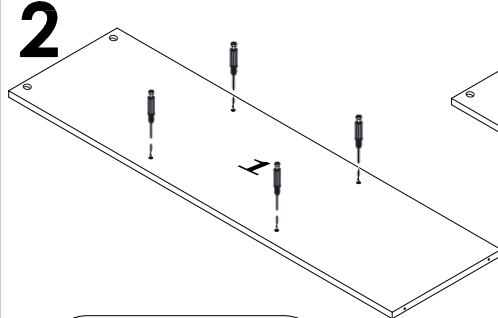

3

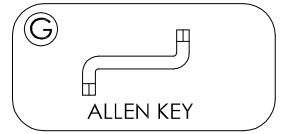
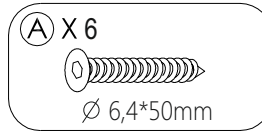
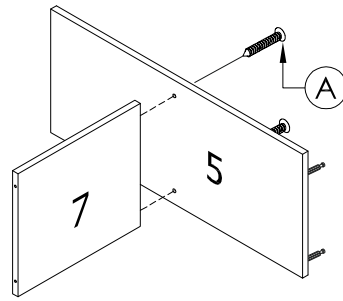
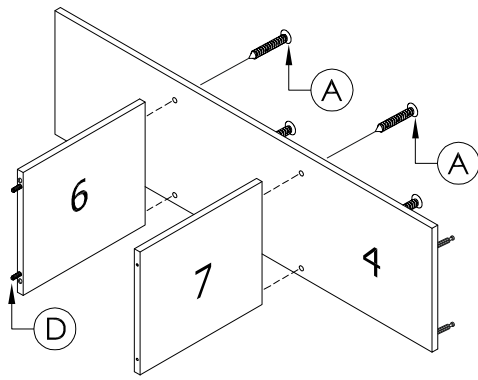

4

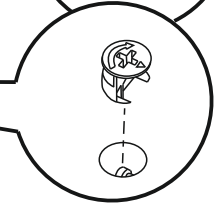
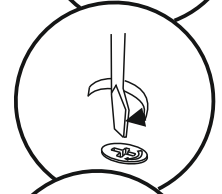
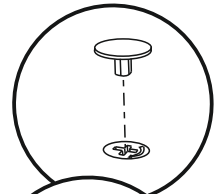
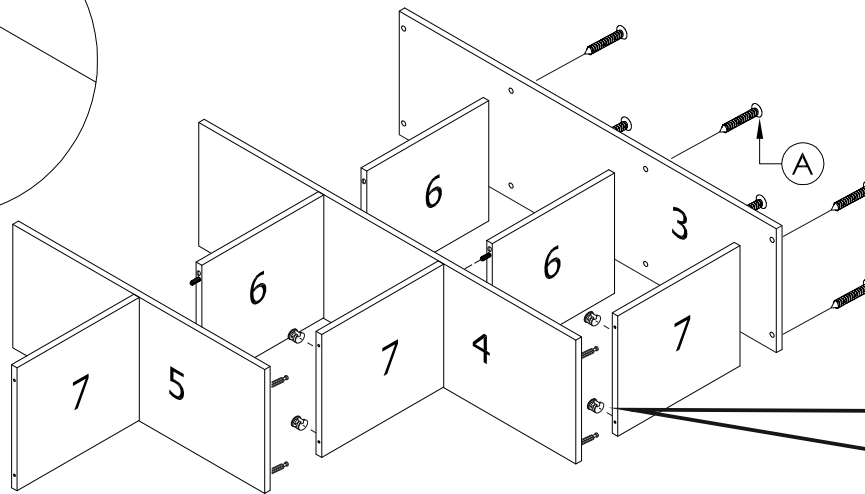
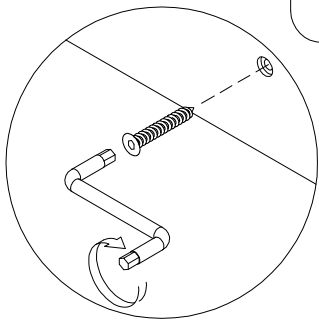
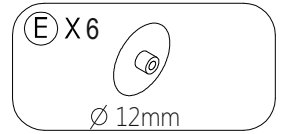
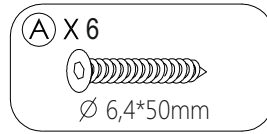
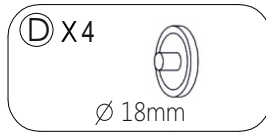
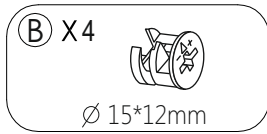

5

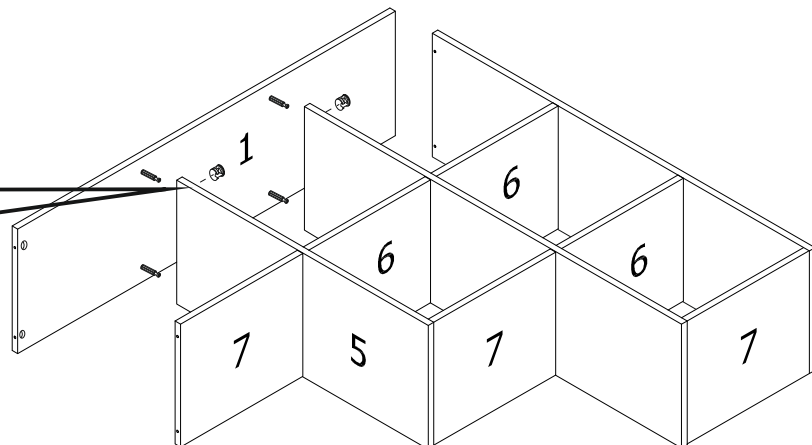
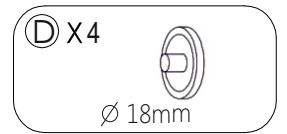
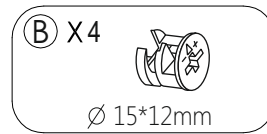
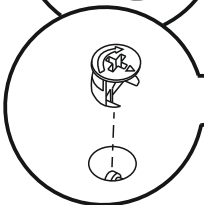
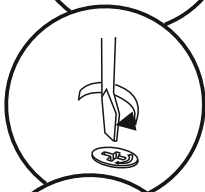
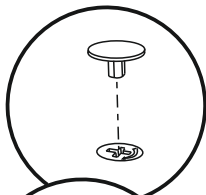

**6**

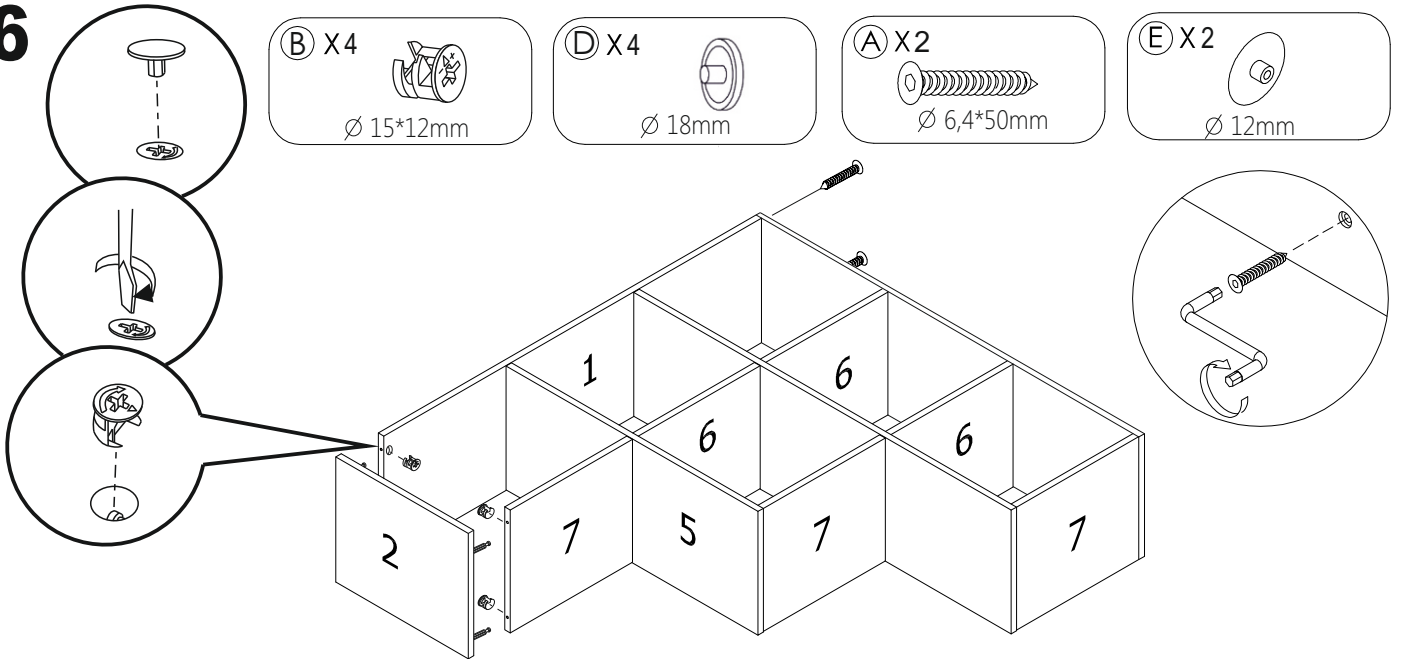

**7**

1	1013x290
2	361x292
3	1047x292
4	1030x288
5	687x288
6,6,6	327x286
7,7,7	327x286

